



\*\*\*\*\*

**HIGH POWER FREE FLOATING TYPE RECTIFIER DIODE**

**Features:**

- . Free-floating silicon technology
- . Low on-state and switching losses
- . Blocking capability up to 5600 volts
- . Optimum power handling capability
- . Pressure assembled device

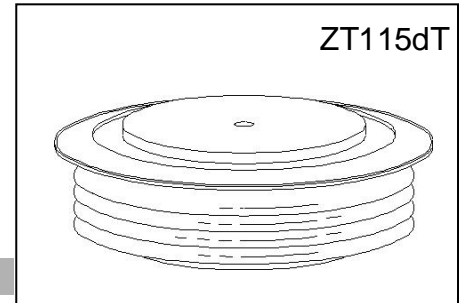

**ELECTRICAL CHARACTERISTICS AND RATINGS**

**Reverse Blocking**

Device Type	V <sub>RRM</sub> (1)	V <sub>RSM</sub> (1)
ZP4500-44	4400	4600
ZP4500-48	4800	5000
ZP4500-52	5200	5400
ZP4500-56	5600	5800

Notes:

All ratings are specified for T<sub>j</sub>=25 °C, unless otherwise stated

- (1) All voltage ratings are specified for an applied 50Hz/60Hz sinusoidal waveform over the temperature range 0 to +150 °C.
- (2) 10 msec. max. pulse width
- (3) Maximum value for T<sub>j</sub> = 150 °C.
- (4) See parameter definition below :

V<sub>RRM</sub> = Repetitive peak reverse voltage  
 V<sub>RSM</sub> = Non repetitive peak reverse voltage (2)

Repetitive peak reverse leakage current	I <sub>RRM</sub>	5 mA 200 mA (3)
---	------------------	--------------------

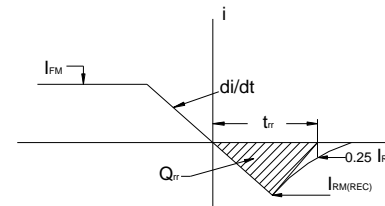

REVERSE RECOVERY CHARACTERIST

**Conducting - on state**

Parameter	Symbol	Min.	Max.	Typ.	Units	Conditions
Average forward current	I <sub>F(AV)</sub>		4500		A	Sinewave 180°, T <sub>c</sub> = 85°C
RMS forward current	I <sub>FRMS</sub>		7065		A	Nominal value
Peak one cycle surge (non repetitive) current	I <sub>FSM</sub>		70000		A	10 msec (50Hz), sinusoidal wave-shape, 180° conduction, T <sub>j</sub> = 150 °C
I square t	I <sup>2</sup> t		2.5 × 10 <sup>7</sup>		A <sup>2</sup> s	10 msec
Peak forward voltage	V <sub>FM</sub>		1.45		V	I <sub>FM</sub> = 5000A; T <sub>j</sub> = 25°C
Threshold voltage	V <sub>FO</sub>		0.82		V	T <sub>j</sub> = 150°C, I = 0.5 π I <sub>F(AV)</sub> to 1.5 π I <sub>F(AV)</sub>
Slope resistance	r <sub>F</sub>		0.104		mΩ	T <sub>j</sub> = 150°C, I = 0.5 π I <sub>F(AV)</sub> to 1.5 π I <sub>F(AV)</sub>
Reverse Recovery Current (4)	I <sub>RM(REC)</sub>				A	I <sub>FM</sub> = 500 A; di/dt = -10 A/s; T <sub>jmax</sub>
Reverse Recovery Charge (4)	Q <sub>rr</sub>				μC	I <sub>FM</sub> = 500 A; di/dt = -10 A/s; T <sub>jmax</sub>
Reverse Recovery Time (4)	t <sub>rr</sub>				μs	I <sub>FM</sub> = 500 A; di/dt = -10 A/s; T <sub>jmax</sub>

Parameter	Symbol	Min.	Max.	Typ.	Units	Conditions
Operating temperature	$T_j$	-40	+150		°C	
Storage temperature	$T_{stg}$	-40	+150		°C	
Thermal resistance - junction to case	$R_{\Theta(j-c)}$		0.0057		°C/W	Double sided cooled
Thermal resistance - case to heatsink	$R_{\Theta(c-s)}$		0.0015		°C/W	Double sided cooled
Mounting force	P			90	kN	
Weight	W			2.90	kg.	

\* Mounting surfaces smooth, flat and greaseless

**CASE OUTLINE AND DIMENSIONS**

